

Guide Post

EUROPEAN STANDARD

GPF03

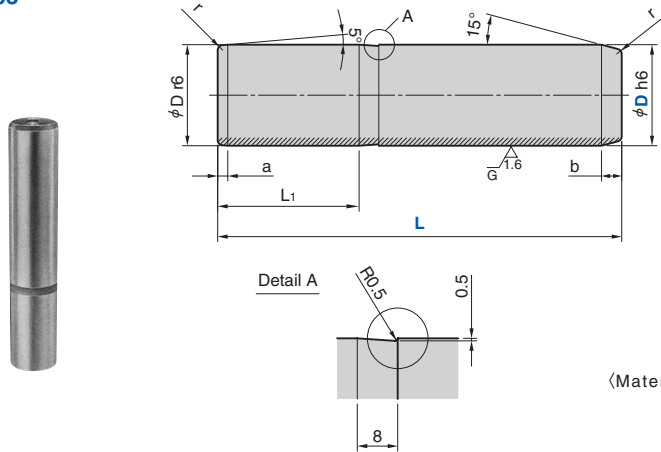

(Material) 42CrMo4V (SCM440)
Hatched Area
HRC60 to 64
Depth 1.0 to 1.5mm

Catalog No.	D	L	L ₁	a	b	r
	16	125	36		2	
	20	125	40			
		140				
		125		3		
		140		4		
	25	160	45			
		180				
		200				
GPF03		140				2
	32	180	45			
		200				
		224				
		140		4	8	
		160				
	40	180				
		200	56			
		224				
		250				
		280				

D	Tolerance	
	h6	r6
16	0 -0.011	+0.034 +0.023
20	0 -0.013	+0.041 +0.028
25		
32		
40	0 -0.016	+0.050 +0.034
50		
63	0 -0.019	+0.060 +0.041

Catalog No.	D	L	L ₁	a	b	r
		160				
		180				
		200				
		224				
	50	250	70			
		280				
		315				
		355				
GPF03		160		4	10	2.5
		180				
		200				
		224				
	63	250	80			
		280				
		315				
		355				
		400				



Catalog No. — D — L
GPF03 — 32 — 200