

Planeveyor Unit

AIR OPERATED LIFTER TYPE

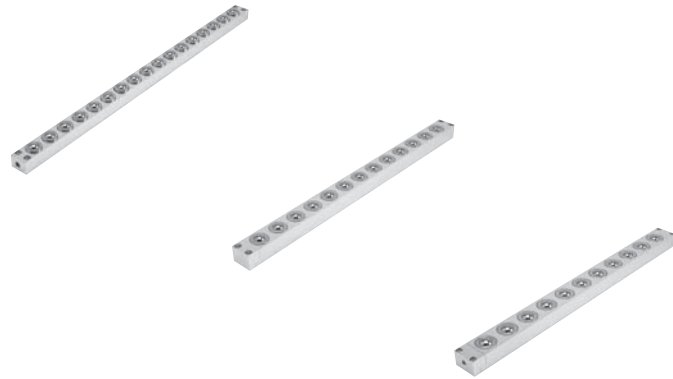

PVLS30

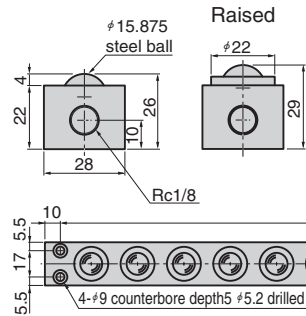

■ Operation air pressure and load capacity per roller

Operating Air Pressure	Mpa	0.4	0.5	0.6
	(kgf/cm ²)	(4)	(5)	(6)
Load Capacity	N	137	167	196
	(kgf)	(14)	(17)	(20)

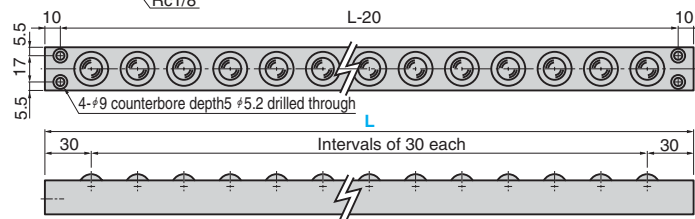

Material : Frame Aluminum
Ball SUJ2

PVLS40

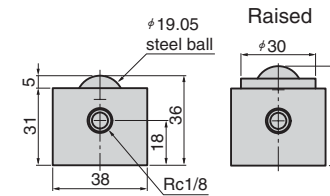

■ Operation air pressure and load capacity of per roller

Operating Air Pressure	Mpa	0.4	0.5	0.6
	(kgf/cm ²)	(4)	(5)	(6)
Load Capacity	N	235	294	353
	(kgf)	(24)	(30)	(36)

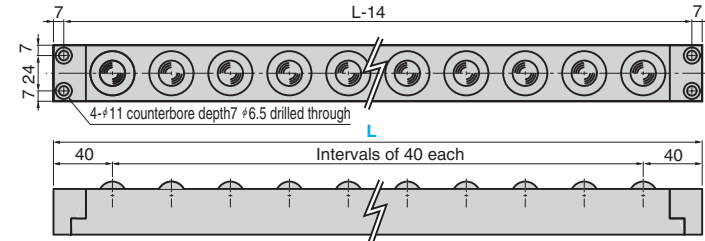

Material : Frame Aluminum
Ball SUJ2

PVLS50

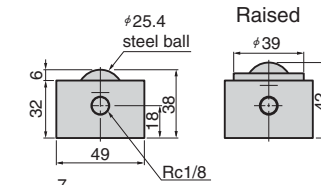

■ Operation air pressure and load capacity per roller

Operating Air Pressure	Mpa	0.4	0.5	0.6
	(kgf/cm ²)	(4)	(5)	(6)
Load Capacity	N	432	539	647
	(kgf)	(44)	(55)	(66)

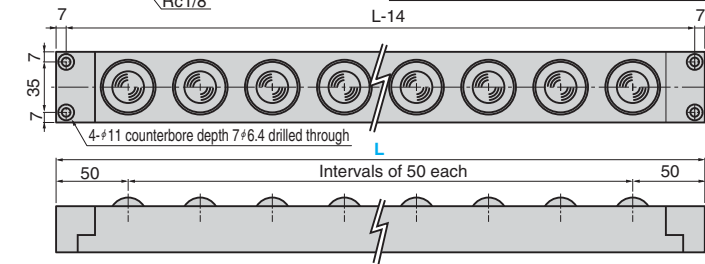

Material : Frame Aluminum
Ball SUJ2

Catalog No.	Nominal size	L
PVLS	30	60~(increments of 30)
	40	80~(increments of 40)
	50	100~(increments of 50)

⚠ The length can be ordered for each interval. However, the interval cannot be changed.



Order

Catalog No.	Nominal Size	-	L
PVLS	30	-	180

⚠ PVLS is made to order.