

SOAPC

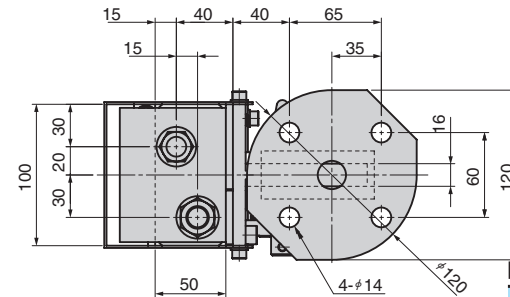

Condition in storage

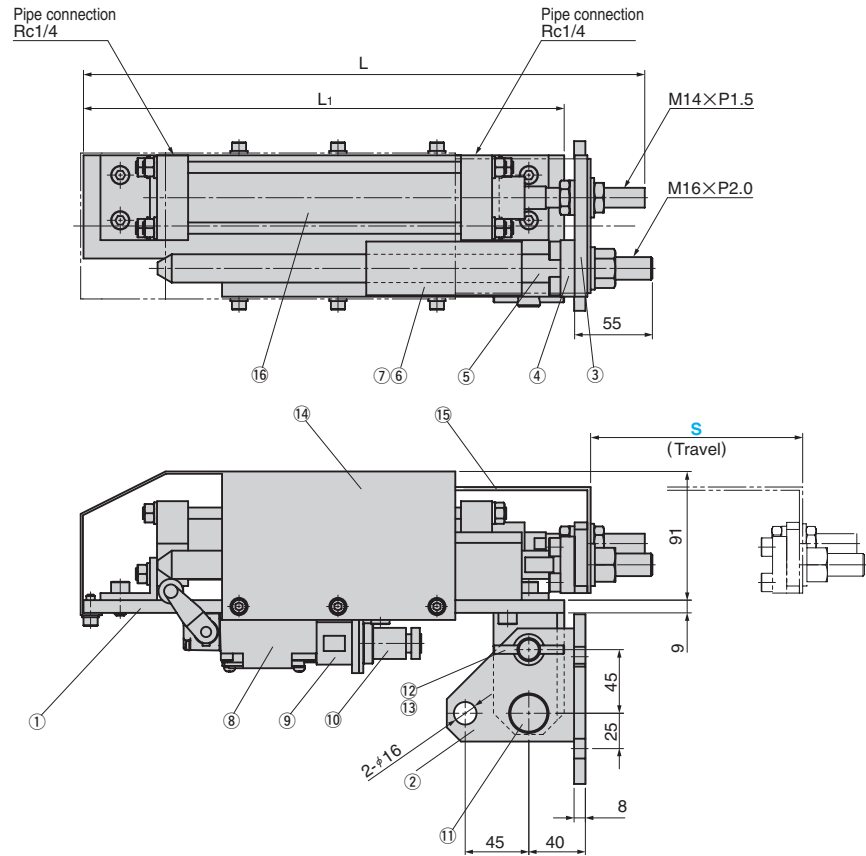
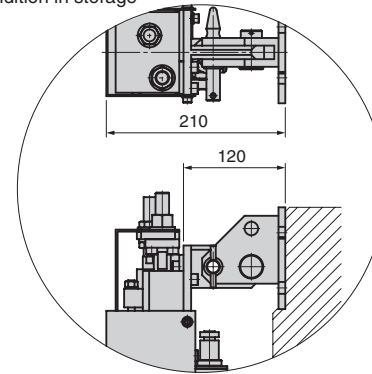

Table of Components

No.	Description	Qty	Material and Remark
①	Base Plate	1	SS400
②	Bracket	1	SS400
③	Connector Plate	1	SS400
④	Set Plate	1	SS400
⑤	Guide Pin	1	S45C
⑥	Bushing Holder	1	SS400
⑦	Guide Bushing	2	FC250 with Graphite
⑧	Limit Switch	1	1LS-J By Yamatake
⑨	Connector Holder	1	SS400
⑩	Connector	1	NCS-252P/R By Nanao
⑪	Joint Pin	1	S45C
⑫	Stopper Pin	1	S45C
⑬	Chain	1	Height : 200 mm
⑭	Cover	1	SPC
⑮	Cover	1	SPC
⑯	Air Cylinder	1	Special part

L	L ₁	Catalog No.	Travel S
395	340	SOAPC	150
495	440		250



Order

Catalog No.	S
SOAPC	150

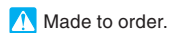

Made to order.

For Operation

- The unit can be folded when the die is stored.
- Use this unit for ejection of small or intermediate sized panels.

Refer to page 429 for pusher swivel adapter.